

FB 355

Backward Curved - Ø 355 mm Centrifugal Fans



Fan Type	Motor	Air Flow m ³ /hr	Speed RPM	Input Power W	Operating from Pa
FB 355 E	DF 102 AA	3000	1880	240	125
FB 355 F	DF 102 BA	2650	1660	165	100

Product Dimensions

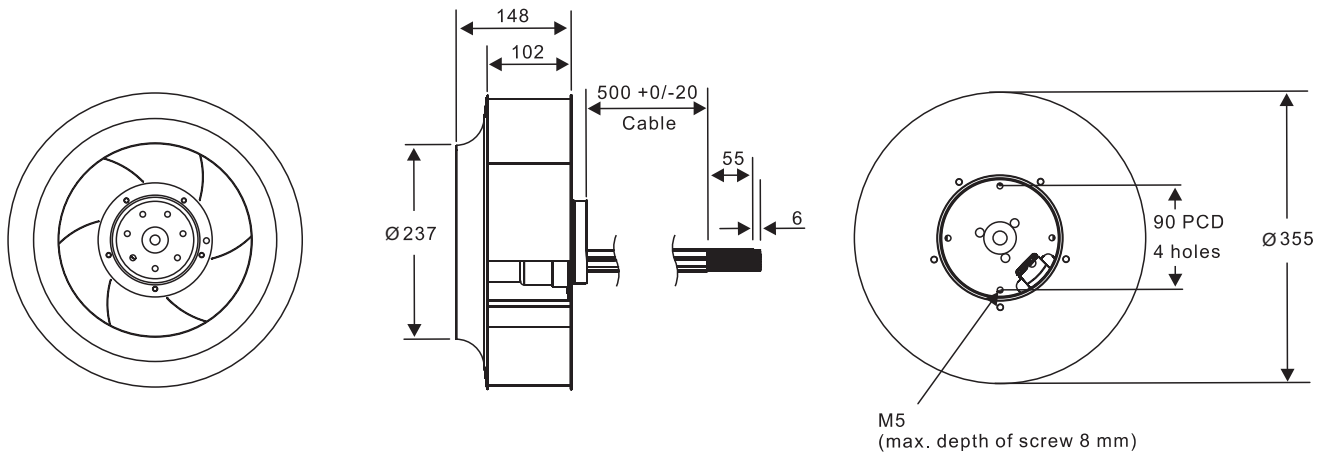

Impeller Material: Galvanized Sheet Steel (Aluminium on request)

All dimensions mm

Air Flow Graph

- Lines drawn are recommended operating limits.
- By adjusting the motor speed, fans can operate at all pressure-flow points up to and including those drawn.

