

Backward Curved Centrifugal Fan Ø 400 mm (15 3/4 inches)

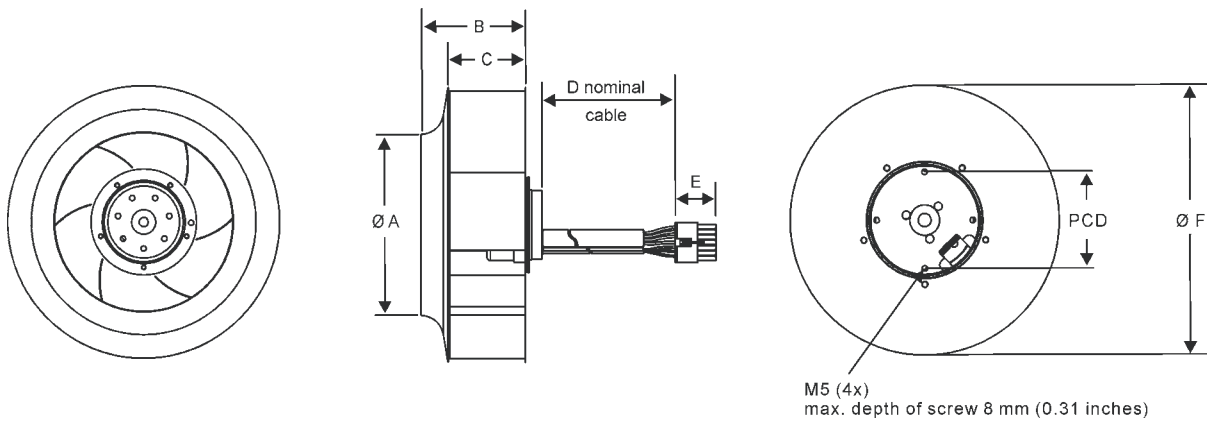

Fan Type	Motor	Air Flow m ³ /hr	Speed RPM	Input Power W	Operating from Pa
FB 400 E	DF 102 AA	2880	1445	340	93
FB 400 F	DF 102 BA	2685	1140	150	0

Product Dimensions:



Material: Galvanized Sheet Steel (Aluminium on request)

Dimensions	A	B	C	D*	E	F	PCD
mm	265	163	112	600	20	400	90
inches	10.43	6.42	4.41	23.62	0.79	15.75	3.54

Cable Tolerance: D* ±10 mm (±0.39 inches)

Air Flow Graph:

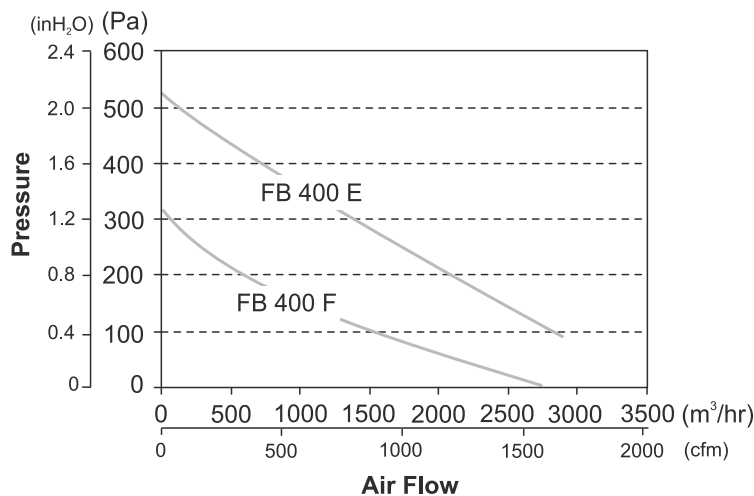

Lines drawn are recommended operating limits. By adjusting the motor speed, fans can operate at all pressure-flow points up to and including those drawn.