

FB 400

Backward Curved - Ø 400 mm Centrifugal Fans



Fan Type	Motor	Air Flow m ³ /hr	Speed RPM	Input Power W	Operating from Pa
FB 400 E	DF 102 AA	3605	1580	260	110
FB 400 F	DF 102 BA	2840	1245	125	70

Product Dimensions

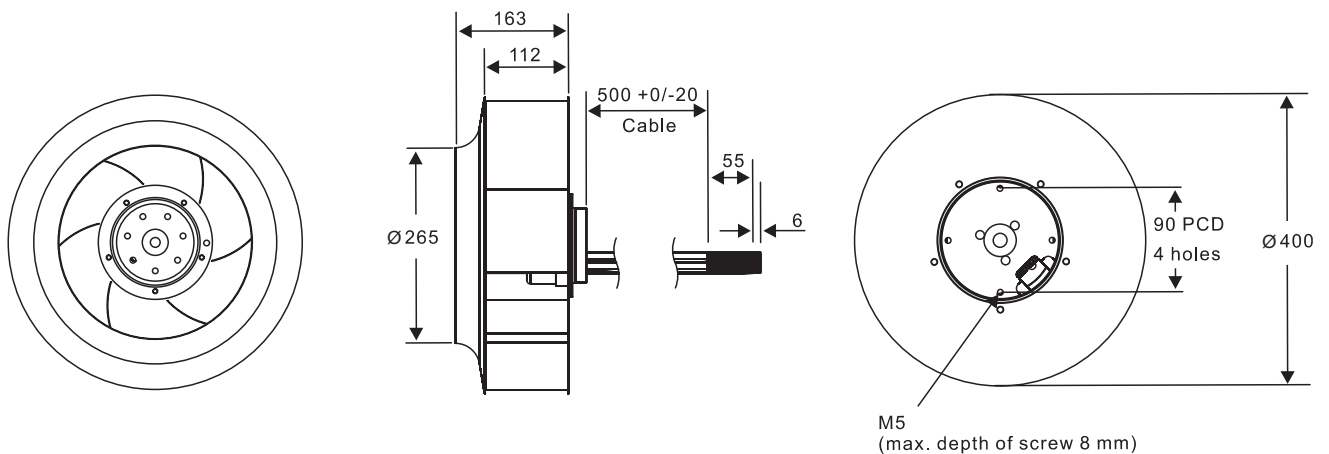

Impeller Material: Galvanized Sheet Steel (Aluminium on request)

All dimensions mm

Air Flow Graph

- Lines drawn are recommended operating limits.
- By adjusting the motor speed, fans can operate at all pressure-flow points up to and including those drawn.

