

FG 200

Forward Curved - Ø 200 mm Double Inlet Impeller



Fan Type	Motor	Air Flow m ³ /hr	Speed RPM	Input Power W	Operating from Pa
FG 200 E	DF 102 AA	2045	890	155	90
FG 200 F	DF 102 BA	1595	695	75	55

Product Dimensions

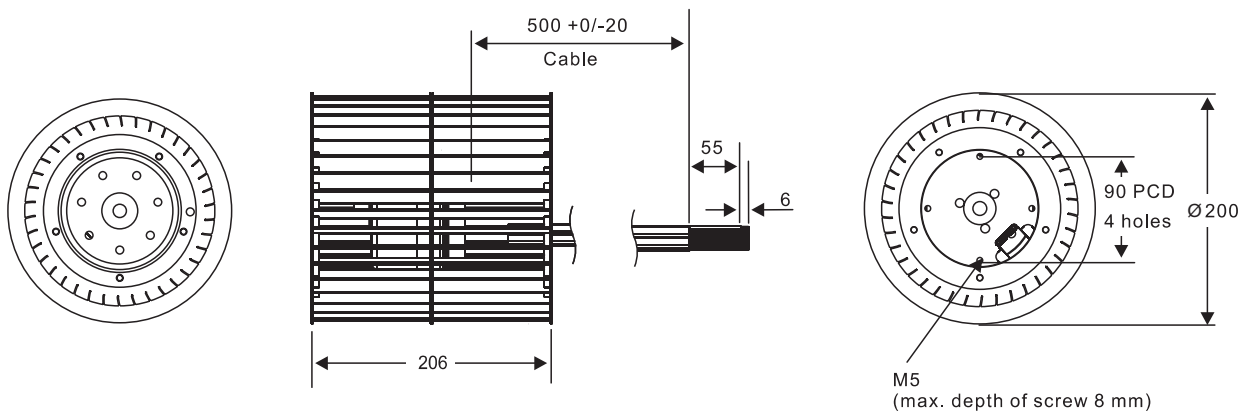

Impeller Material: Galvanized Sheet Steel (Aluminium on request)

All dimensions mm

Air Flow Graph

- Lines drawn are recommended operating limits.
- By adjusting the motor speed, fans can operate at all pressure-flow points up to and including those drawn.

